



MEDIA MIRROR / MEDIA MIRROR PLUS DUPLICATOR

USER MANUAL





| | | |
|-------------|------------------------------|-----------|
| I. | INTRODUCTION | 2 |
| 1. | Features | 2 |
| 2. | LCD and Front Panel Overview | 2 |
| 3. | Specifications | 4 |
| II. | WARNING | 5 |
| III. | MENU | 5 |
| 1. | Disc to Disc | 5 |
| 1.1 | Copy | 5 |
| 1.2 | Copy + Compare | 5 |
| 1.3 | Source Select | 6 |
| 2. | Flash to Disc | 6 |
| 2.1 | Copy | 6 |
| 2.2 | Multi Session | 7 |
| 2.3 | Set Oversize File | 7 |
| 2.4 | Set Span Mode | 8 |
| 3. | Disc to Flash | 8 |
| 4. | Flash to Flash | 8 |
| 4.1 | Copy File | 8 |
| 4.2 | Copy Disk Data | 9 |
| 4.3 | Copy All Disk | 9 |
| 5. | Utility | 9 |
| 5.1 | Disc Information | 9 |
| 5.2 | Drive Information | 10 |
| 5.3 | System Information | 10 |
| 5.4 | Update BIOS | 10 |
| 5.5 | HDD Manager | 11 |
| 6. | Setup | 14 |
| 6.1 | Set Burn Speed | 14 |
| 6.2 | Start Up Menu | 14 |
| 6.3 | Auto Start | 15 |
| 6.4 | Display Mode | 15 |
| 6.5 | Language | 15 |
| 6.6 | Set Time Zone | 15 |
| 6.7 | Clear Setup | 16 |
| 6.8 | Advanced Setup | 16 |
| IV. | BASIC TROUBLESHOOTING | 18 |

I. Introduction

The Media-Mirror/Media-Mirror-Plus Backup System is a multiple-purpose duplicator which can copy from CD/DVD/Blu-ray disc to CD/DVD/Blu-ray disc, multiple USB/memory cards to one CD/DVD/Blu-ray disc, and backup one larger size USB/Memory card into proper number of CD/DVD/Blu-ray discs. Furthermore, Media-Mirror-Plus series include additional USB/Memory card slots that allow you to copy directly from one USB/Memory card to the other USB/Memory card, featuring “Data Appending” technology which allows copying data to a USB/Memory card without erasing the existing data. The Media-Mirror-Plus series can also copy from a CD/DVD/Blu-ray disc to a USB/Memory card.

1. Features

- Supports Disc to Disc and Flash to Disc duplication
- Supports Multi-Session and Disc Spanning
- Supports Flash to Flash and Disc to Flash duplication (Media-Mirror-Plus model ONLY)
- Supports various flash media interfaces such as USB, SD, CF and MS
- Supports high speed duplication up to 24X for DVD, 56X for CD and 12X for Blu-ray
- Easily copy CD/ DVD/ Blu-ray/ Flash media with one duplicator machine.
- Data Appending: Allows data appending to a USB/Memory card without erasing the existing data content (Media-Mirror-Plus model ONLY)

2. LCD and Front Panel Overview

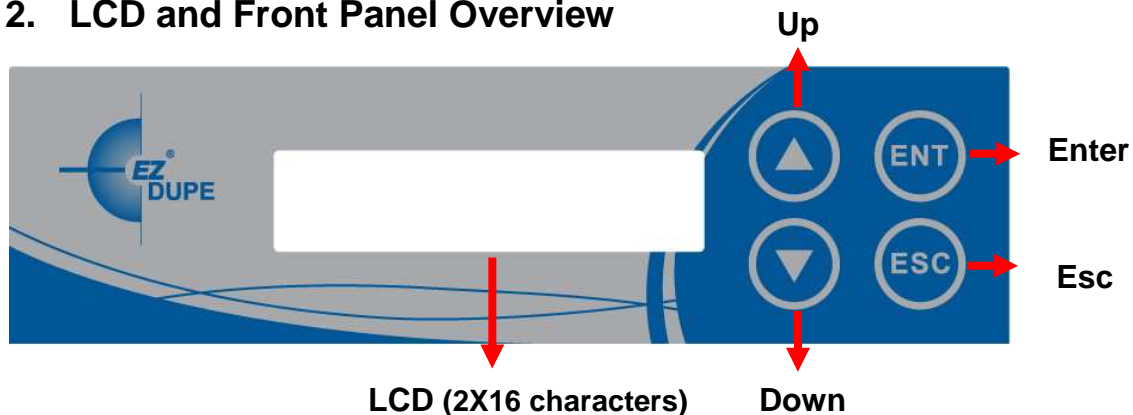

▲ Button: Up, Backward: To navigate backward in the menu.

▼ Button: Down, Forward: To navigate forward in the menu.

ENT Button: Enter, OK: Execute the function.

BACK Button: Escape, Cancel: Go back to the previous level in the menu.

Front panel with USB/Memory card interface is illustrated below.

Media-Mirror Duplicator:



Use only one of the USB, CF, SD or MS slots as the source for duplication. Do not plug in 2 or more USB and memory cards as source at the same time.

Media-Mirror-Plus Duplicator:

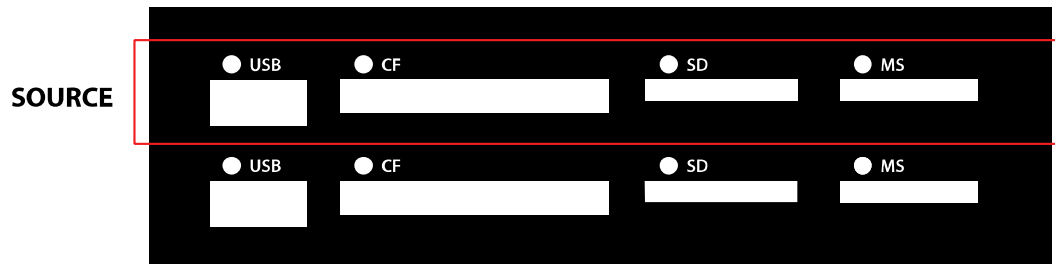

Use only one of the USB, CF, SD or MS slots on the top row as the source and one of the slots at the 2nd row below as target for duplication. Do not plug in 2 or more USB and memory cards as source or target at the same time.

3. Specifications

| | |
|---|--|
| Model | Media-Mirror/Media-Mirror-Plus Duplicator |
| Internal Interface | SATA (Serial ATA) |
| Operation | Standalone (No PC or Software is required) |
| Supported Format | <p>MS Slot: MS, MS-Duo, MS Pro, MS Pro Duo, MS MagicGate, MS Pro MagicGate, MS-Duo MagicGate, MS Pro Duo MagicGate</p> <p>CF Slot: CF I, CFII, Micro Drive</p> <p>SD Slot: SD, SD Pro, Mini SD*, Mini SD Pro*, Micro SD*, SD HS,WI-FI SD, Super HS SD SDXC SDHC (*Adapter Required)</p> <p>MMC Slot: MMC, MMC Pro, MMC II, RS-MMC</p> <p>Discs: DVD-ROM, DVD-Video, DVD+R, DVD+RW, DVD-R, DVD-RW, Dual Layer DVD-R, CD-ROM, CD-I, Audio CD, Video CD, Bootable CD, Mixed-mode CD, Multi-session CD, CD-Plus, Business Card CD, 3" Mini CD-R</p> <p>USB Drive</p> |
| Writing Method | DAO, TAO |
| Backup Method | Single Session/Multi-Session /Disc Spanning |
| Disc Writing Speed | DVD-R: 24X, DVD+R: 24X, DVD-RW: 6X, DVD+RW: 8X, DVD+R DL: 8X, DVD-R DL: 8X, CD-RW: 40X, CD-R: 52X(Actual writing speed depends on media & drive specifications) |
| Power Supply | 115V or 230V (Selector Switch) |
| Flash Copy Speed | Up to 2GB per Minute |
| Supported File System Format (for Copy Disk Data of Flash to Flash) | <p>Windows : FAT16/32, exFAT, NTFS</p> <p>Linux : ext2/3/4</p> <p>OSX : HFS/HFS+</p> |
| Supported File System Format (for Copy file of Flash to Flash, Flash to Disc, and Disc to Flash) | FAT16, FAT32, exFAT |

II. Warning

1. The Green LED flashes during the execution process of task. After the task is done, the Green LED will stay solid if the process is successful, otherwise the Red LED will be on if the process is failed.
2. DO NOT turn off the duplicator machine when the task is under process. It may damage the duplicator or the optical drives.
3. DO NOT remove optical drives when the task is under process. It may damage the duplicator or the optical drives.
4. DO NOT plug in USB or flash memory card until the duplicator boots up. It may cause abnormal results if a USB or flash memory card with quality issue is plugged in when boots up.
5. It is strongly recommended that the capacities of the source and target media are equal or similar.
6. The media plugged into the source slot cannot be overwritten (it is read only), avoiding erasing the original data accidentally.

III. Menu

1. Disc to Disc

1.1 Copy

It is important to make sure that your source disc is placed into the source drive. Normally the top drive under the flash media slots is the source drive for source disc. Select “1. Disc to Disc” from the menu then select “1. Copy” under **[Disc to Disc]**. Place source disc and blank discs into the proper drive trays and press “ENT” button, system will detect the discs and continue the process as below. When place in the source disc, the media type will be showed on the screen.

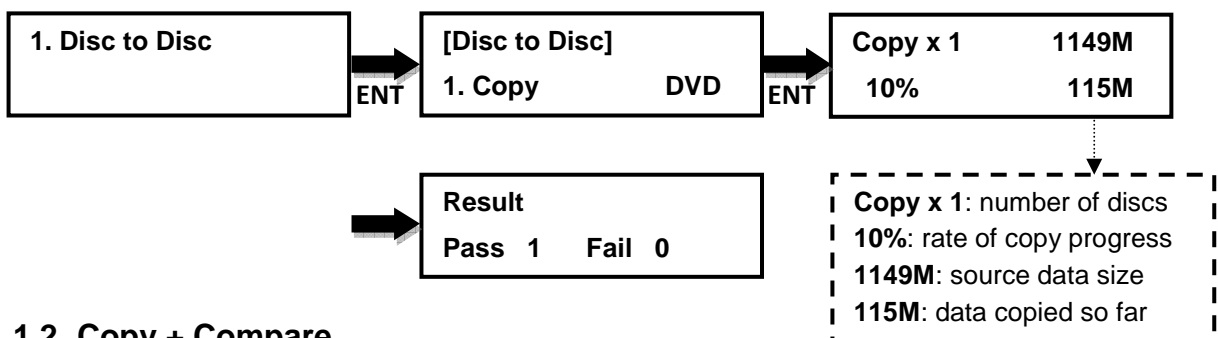

1.2 Copy + Compare

This function performs copy first, then automatically compares between source and copied discs when the copy process is finished.

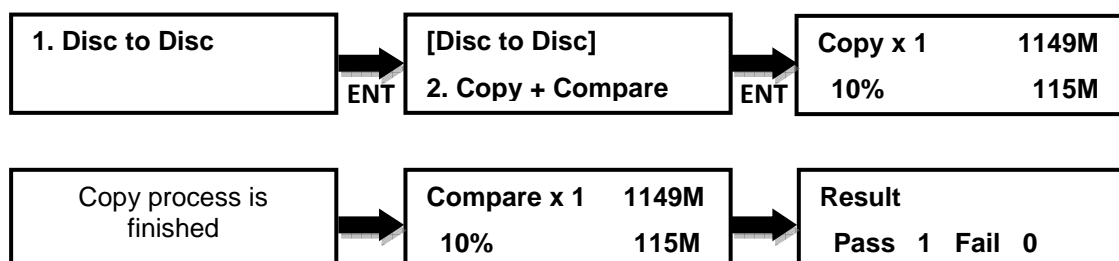

1.3 Source Select

This function allows user to change the source drive to any drive including the Hard Disk Drive (HDD) if it is installed.

Selectable source:

First Drive (default): Choose the first device plugged as source.

HDD: Choose the Hard Disk Drive as source if installed.

[D# 1] Port: 1: Choose port #1 or any other port as source.

Auto: System will detect the port with source disc and set it as the source automatically.

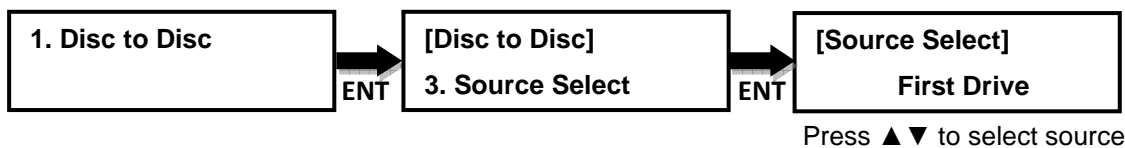

2. Flash to Disc

2.1 Copy

This function will copy from USB or flash memory card to CD/DVD/Blu-ray disc(s). A high capacity USB or memory card with large data content can be copied to several small capacity discs using **Disc Spanning technology**.

Plug in a Flash device (ex: USB, SD, MMS...) into the proper slot as the source and place a blank disc into one CD/DVD/BD writer as target for duplication. When insert the USB drive, the available capacity will be showed on the screen.

Note: Supported files system format for flash are FAT16/32 and exFAT.

a. First example: A USB drive with 119MB data content is copied to a CD disc.

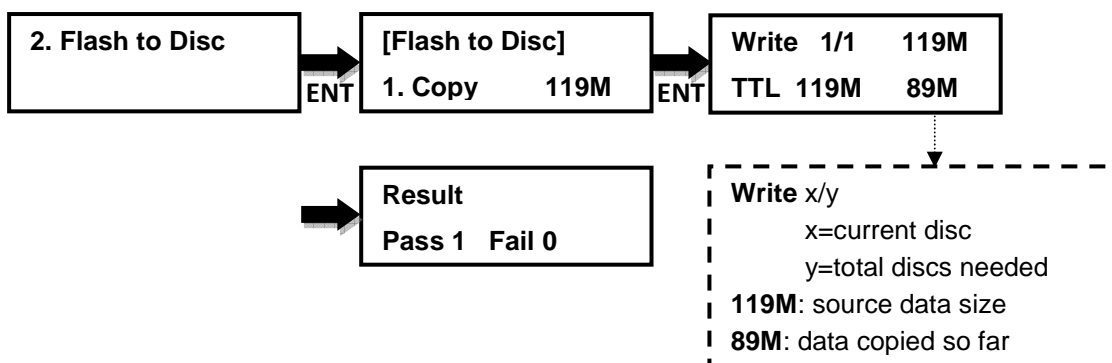

b. Second example: A USB drive with 1115MB data content is copied onto three CD discs.

The system will detect the source and calculate how many discs will be needed. After detecting the number of disc needed, the system will start to copy. When the first blank disc has been written in full with data, it will be ejected automatically and wait for the next blank disc. Remove the copied disc,

put in another blank CD disc and close the tray, then press “ENT” key to continue the copy process.

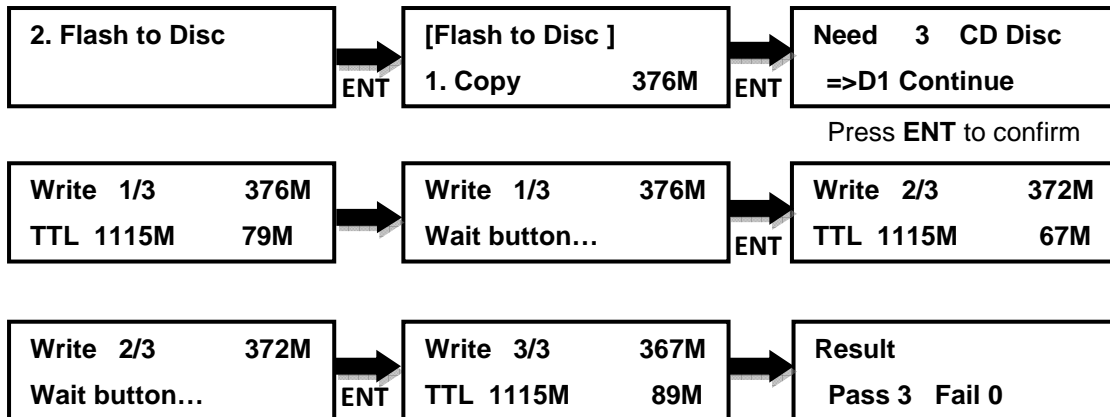

2.2 Multi Session

Allow different types of memory cards with small data to be backed up to one disc.

In the sample below a USB drive with 100MB of data is used as the first source to copy to a blank CD. When the copy finishes, the CD disc will automatically be ejected. Remove USB drive, insert an SD card with 220MB of data as the second source and copy to the same CD disc. After the copy is done, the CD disc will have two sessions of data from both USB drive and SD card.

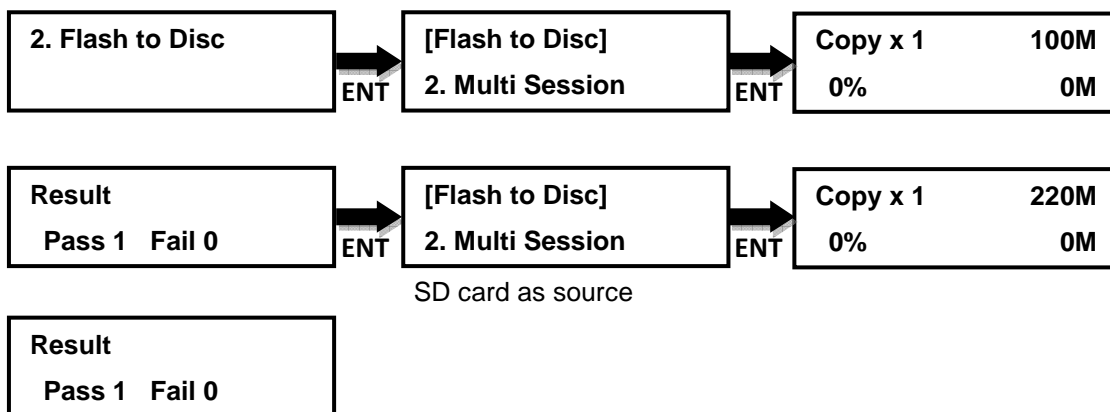

SD card as source

CD disc with two sessions of data

2.3 Set Oversize File

Allow to set Reject/Stop or Skip the copy of oversized files.

“**Reject/Stop Copy**”: System will reject or stop the copy process when the source file’s capacity is larger than a blank target disc.

“**Skip**”: System will proceed copy process and skip the oversize file if its capacity is larger than a blank target disc.

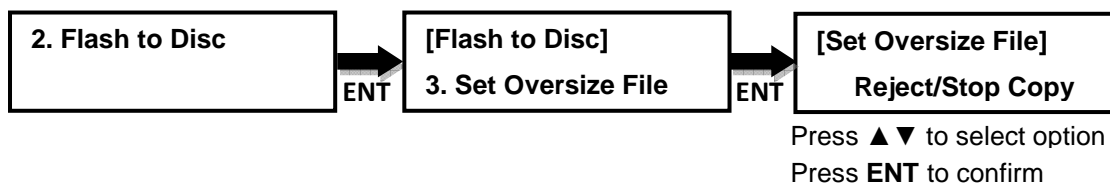

2.4 Set Span Mode

Allow to select span mode to single or multiple target discs.

“Preload loading”: It allows the duplicator to copy data from the source to one blank disc only, and continue to copy the remaining data from the source to another preloaded disc if there is one. For example, a USB drive with 7.5GB data content as source and two blank DVD discs loaded as targets, duplicator will copy 4.5G data from the USB drive onto the first blank DVD disc and copy the remaining 3GB data to the other blank DVD disc.

“Multi Target”: It allows the duplicator to copy data from the source to multiple discs simultaneously. For example, a USB drive with 7.5GB data content as source and two DVD discs loaded as targets, duplicator will copy 4.5G data from the USB drive to the two DVD discs at same time. After swapping the two copied discs with two new blank DVD discs, duplicator will continue to copy the remaining 3GB data to the two discs.

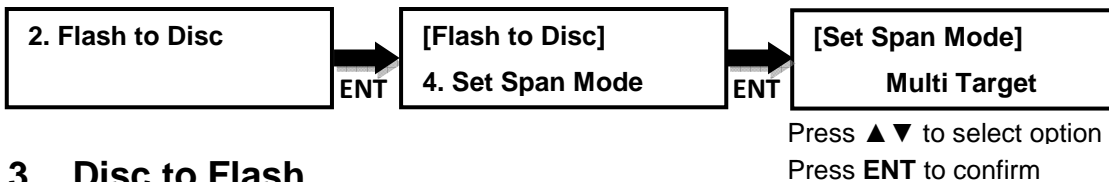

3. Disc to Flash

This function is only available on the Media Mirror Plus model.

It will copy from CD/DVD/BD disc to a USB drive or flash memory card.

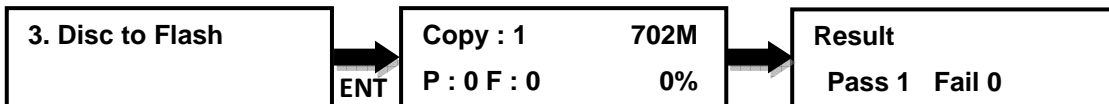

Note: Supported files system format for flash are FAT16/32 and exFAT.

4. Flash to Flash

This function is only available on the Media Mirror Plus model.

4.1 Copy File

Copy files stored in the source USB drive/flash memory card to the target USB drive/flash memory card. The copied files will be appended to the original contents on the target.

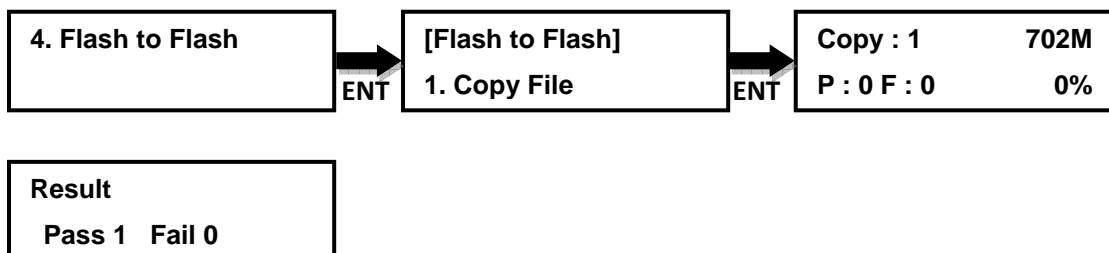

Note:

- a. Original contents will not be erased from the target.

b. Supported files system format for flash are FAT16/32 and exFAT.

4.2 Copy Disk Data

Copy all data area, including data and partition table (system information).

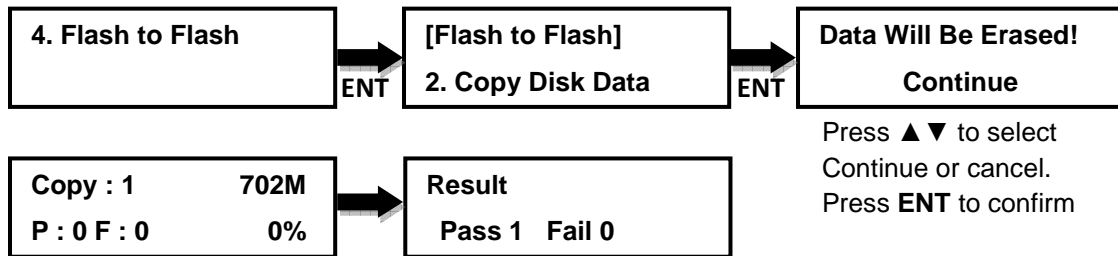

Note: a. Original contents will be erased from the target.

b. Supported file system format for flash are FAT16, FAT32, exFAT, NTFS, ext2, ext3, ext4, HFS, HFS+

4.3 Copy All Disk

Copy the complete contents of a USB drive/flash memory card to another one

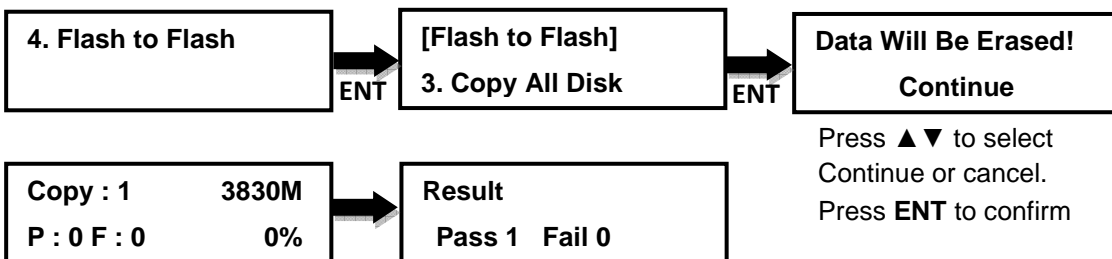

Note:

a. Original contents will be erased from the target.

b. Support all file system formats.

5. Utility

(If it is the Media Mirror model, this section will be under “3.Utility”)

5.1 Disc Information

Display the information of the disc, such as disc format, and content size.

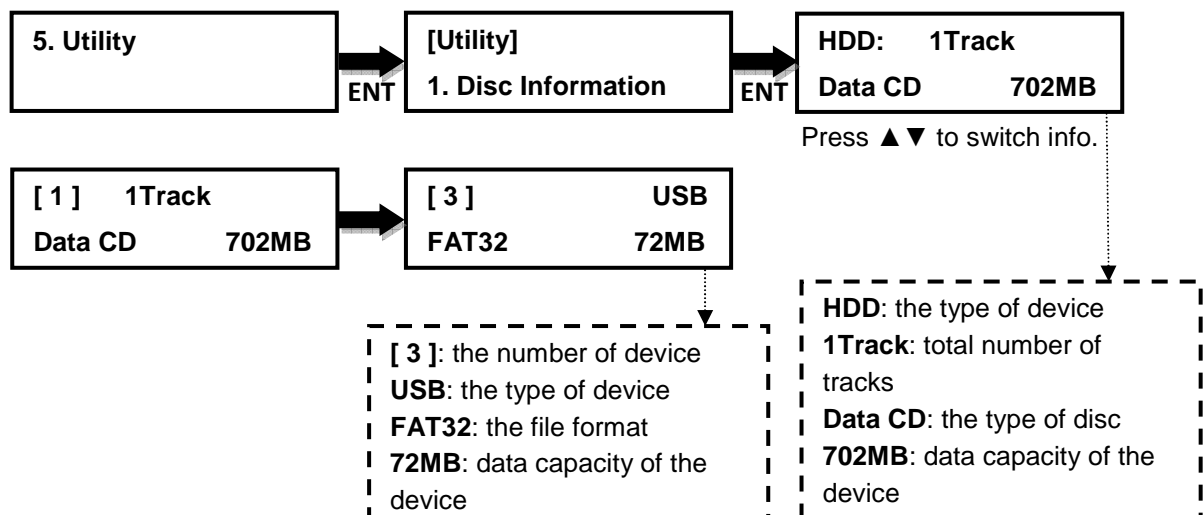

5.2 Drive Information

This function shows the drive info that is connected to each internal port of the controller.

Information includes the port number that each drive is assigned to, brand name and model of each drive and drive firmware version.

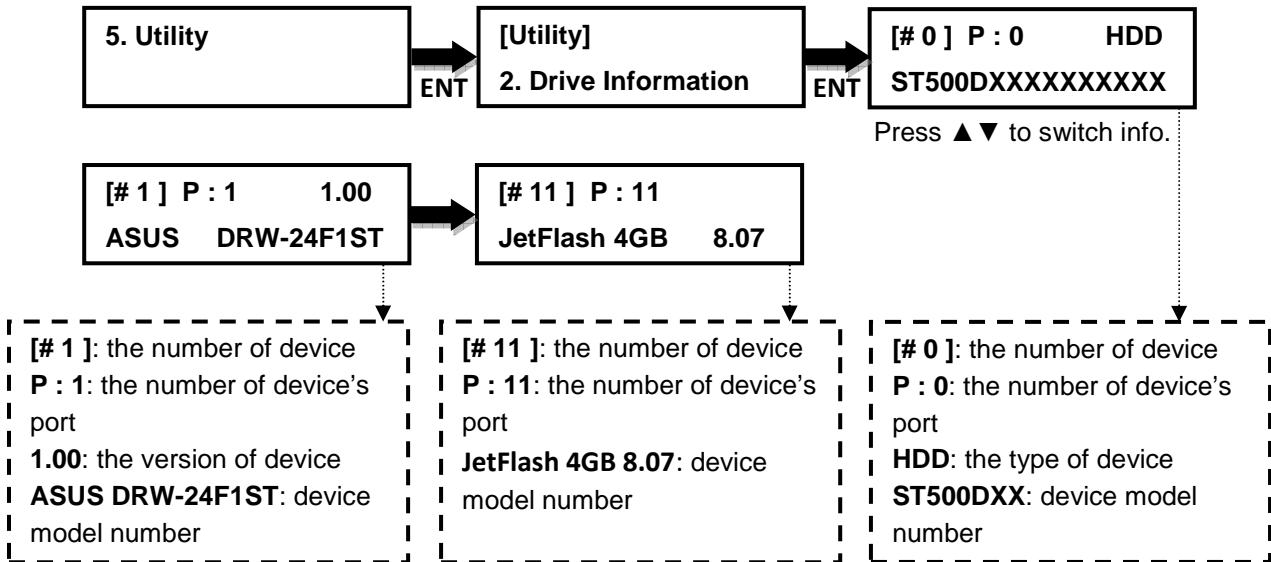

5.3 System Information

This function displays the information of the controller board installed in the duplicator.

Information displayed will be the controller model and firmware version.

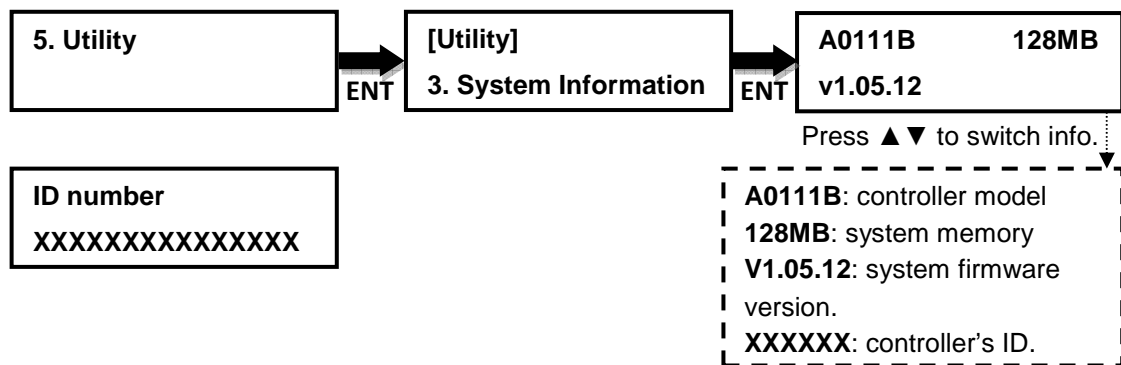

5.4 Update BIOS

This command allows you to update the firmware of duplicator when necessary. Please obtain the proper firmware file from manufacturer and burn it (the un-zipped files) to a CD or DVD supported by the duplicator. Once the update process is completed, the duplicator will reboot automatically to activate the new firmware.

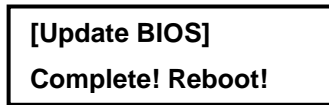
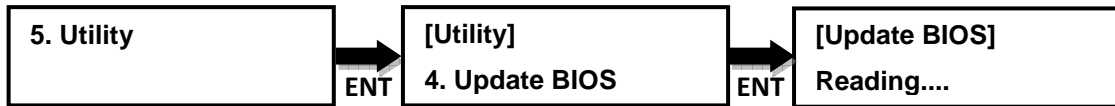

Note:

- a. Please insert the disc with firmware to the source port.
- b. DO NOT put the firmware files in a folder.

5.5 HDD Manager

This command is for the management of the hard disk drive (HDD) installed in the duplicator.

Note: This feature is only available on duplicators with a HDD installed. If there is no HDD present in the duplicator, this feature will NOT show up in the menu of commands.

5.5.1 Select Image

Allows user to select any image that is stored on the HDD.

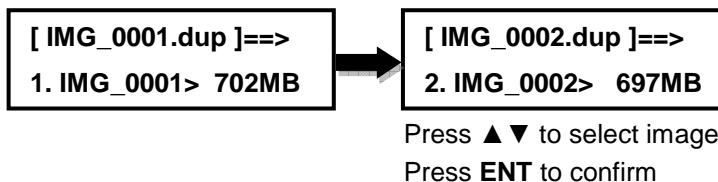
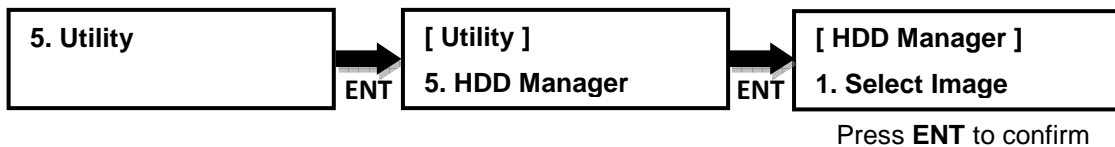

5.5.2 Disc=>Image

Allows user to save the image (data) from the source disc to the HDD.

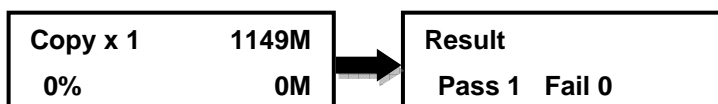
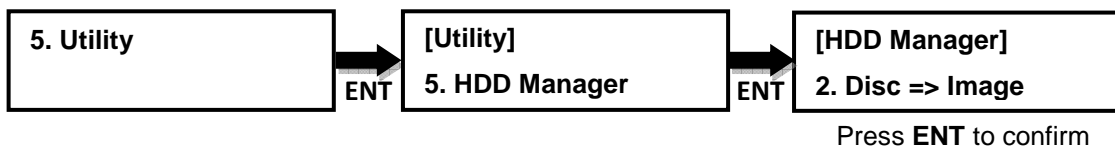

5.5.3 Image Information

Displays the format and content size of each image that is saved on the HDD.

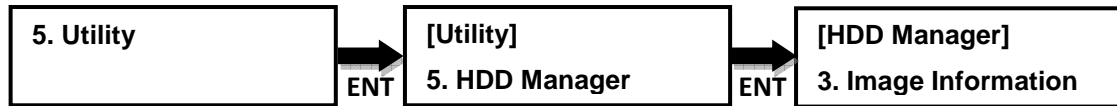

Press **ENT** to confirm

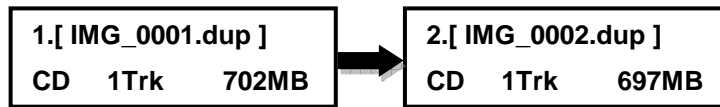

Press ▲▼ to switch

[IMG_0002.dup]: image's name and format
 CD: type of image
 1Trk: the number of image's track
 697MB: image's capacity

5.5.4 Rename Image

This function allows user to rename each image that is saved on the HDD for better identification (up to 8 characters)

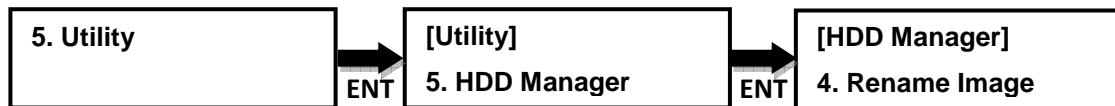

Press **ENT** to confirm

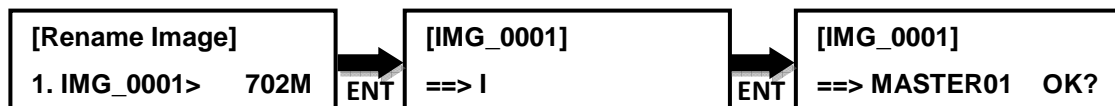

Press ▲▼ to switch image

Press ▲▼ to switch character

Press **ENT** to confirm change

5.5.5 Delete Image

This function allows user to delete any unwanted image that is stored on the HDD.

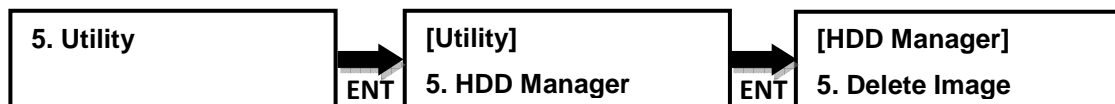

Press **ENT** to confirm

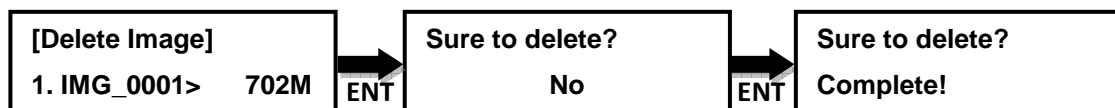

Press ▲▼ to switch image

Press ▲▼ to switch choice

5.5.6 HDD Information

It will display HDD information such as the size of the HDD, number of files and space available.



Press **ENT** to confirm

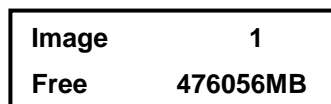
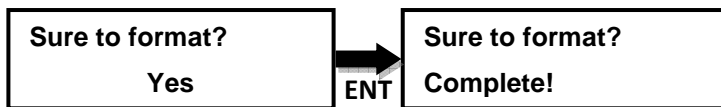
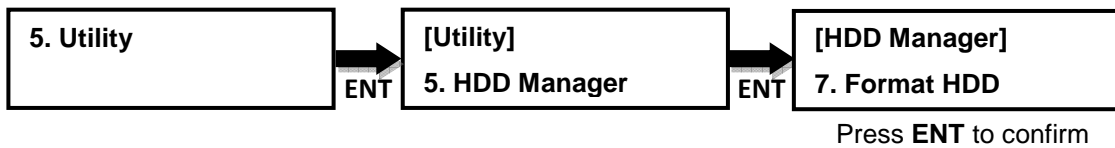

Image 1: number of images on the HDD
 Free 476056MB: remaining free space on the HDD.

5.5.7 Format HDD

Allows user to format the HDD.

Warning: any previously stored images will be lost.



Press ▲ ▼ to switch choice

5.5.8 HDD Setup

5.5.8.1 Load and Copy

This function will load the image from source disc to the HDD and automatically copy the image to the target discs.

“**OFF**”: Turn off this function.

“**Synchronous**”: System will load the image from source disc to the HDD and automatically copy the image to the target discs at the same time.

“**Load First**”: System will load the image to the HDD first, then copy to discs.

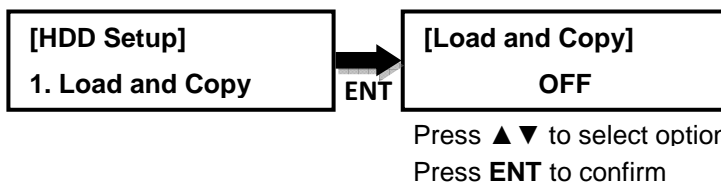
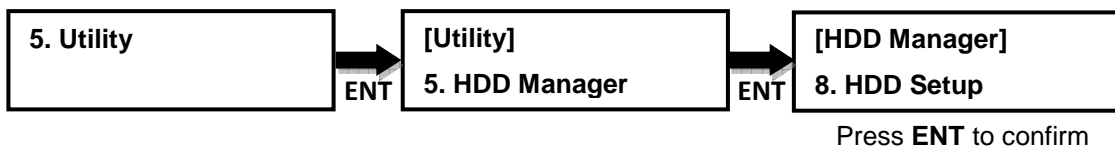

5.5.8.2 Failed Image

If image fails to load properly, the option can automatically delete the image or save the image.

Delete: System will delete the failed image automatically.

Reserve: System will save the image.

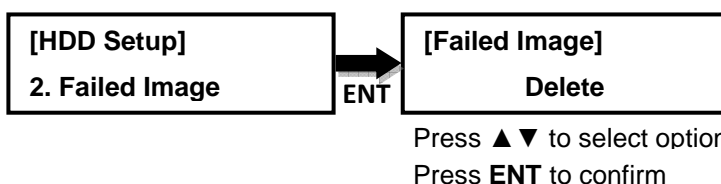
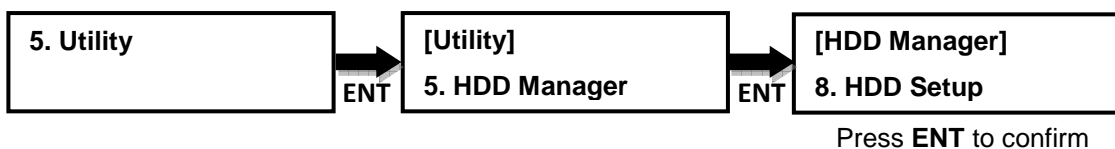

5.5.8.3 Default Image

Allows user to choose the default image.

“**Selected Image**”: Allows user to manually choose which image wish to use as default.

“**First Image**”: Choosing this function will automatically set the first image as default.

“**Latest Image**”: Allows the latest image loaded to the HDD to be the default.

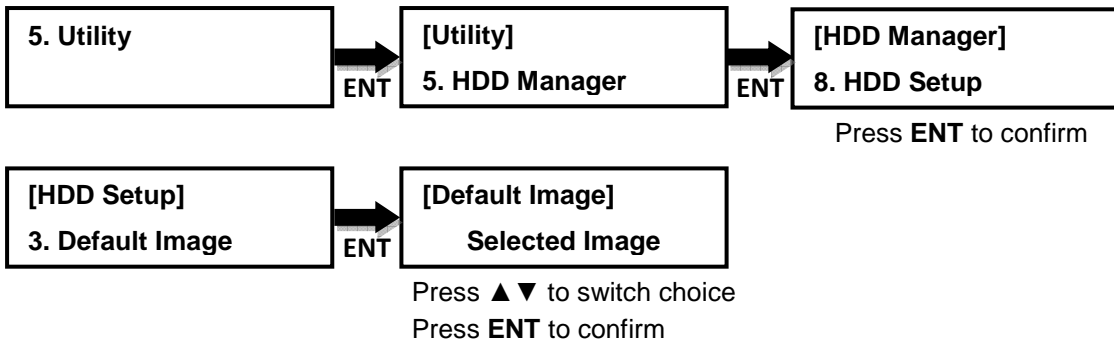

6. Setup

If it is the Media Mirror model, this section will be under “4.Setup”

6.1 Set Burn Speed

Allows user to set the burn speed for duplication needs.

Note: Due to the varying quality of media, a median burn speed is recommended.

Selectable burn speeds:

CD: 1, 2, 4, 8, 10, 12, 16, 20, 24, 32, 36, 40 (default), 44, 48, 50, 52, 56, MAX.

Audio CD: 1, 2, 4, 8, 10, 12, 16, 20, 24 (default), 32, 36, 40, 44, 48, 50, 52, 56, MAX.

DVD: 1, 2, 2.4, 4, 6, 8, 12, 16 (default), 18, 20, 24, MAX.

DVD DL: 1, 2 (default), 2.4, 4, 6, 8, 12, 16, 18, 20, 24, MAX.

Blu-ray: 1, 2 (default), 4, 6, 8, 10, 12, MAX.

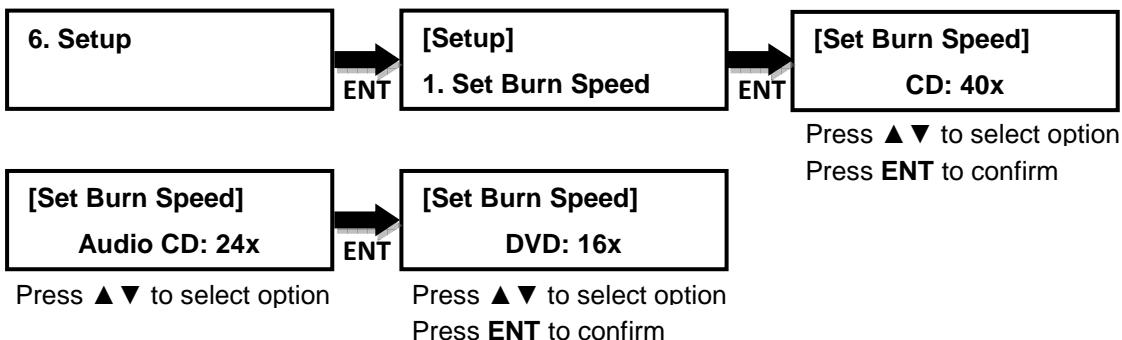

6.2 Start Up Menu

Allows user to choose which function to appear immediately after the duplicator is boot up. All functions are available for selecting from: “**Disc to Disc**”, “**Flash to Disc**”, “**Disc to Flash**”, and “**Flash to Flash**”.



6.3 Auto Start

This allows user choose how much time needed for duplicator to start automatically copying after the last disc is inserted. The time ranges from “**OFF**” (no auto start) to “**120**” seconds.

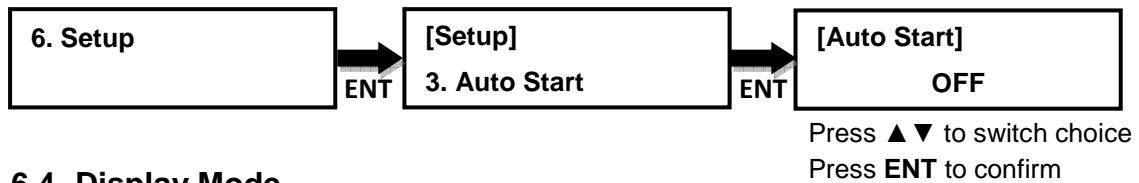

6.4 Display Mode

Allows user to choose the display mode that best suit their needs.

“**Basic**”: displays a progress bar, along with the amount of total data in MB on the master DVD (or in time for the master CD) disc.

“**Expert**”: displays the percentage of the process completed, the amount of data transferred and the total amount of data on the master disc.

“**Show Timer**”: shows progress time bar.

“**Show speed**”: shows the transfer speed in the process.

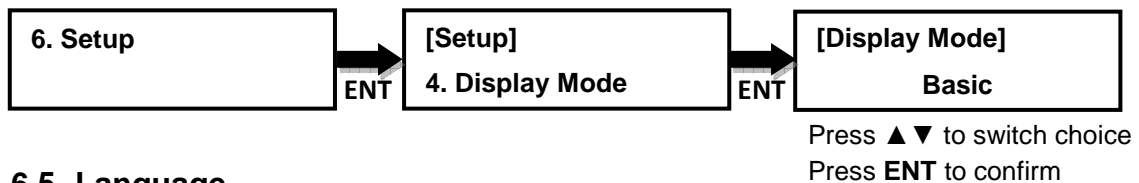

6.5 Language

Allows user to choose From “**English**”, “**Spanish**”, “**Japanese**” or “**Portuguese**”.

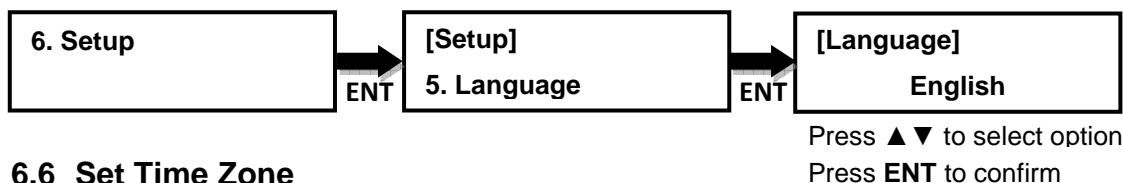

6.6 Set Time Zone

Allows user to set up a time zone for the specific region based on GMT to time stamp the disc copies.

Options: “**GMT +13**” ~ “**GMT -12**”.

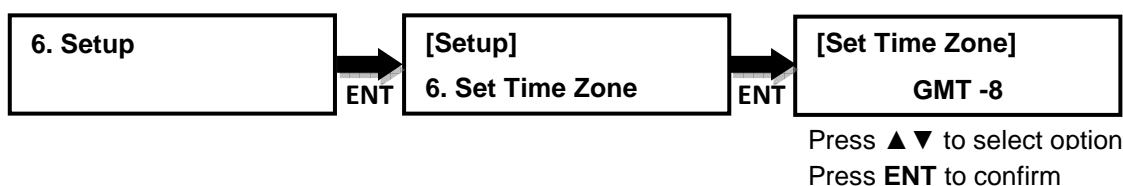

6.7 Clear Setup

This function will set the duplicator back to factory default.

Warning: Do not use this function unless instructed by an authorized technician.

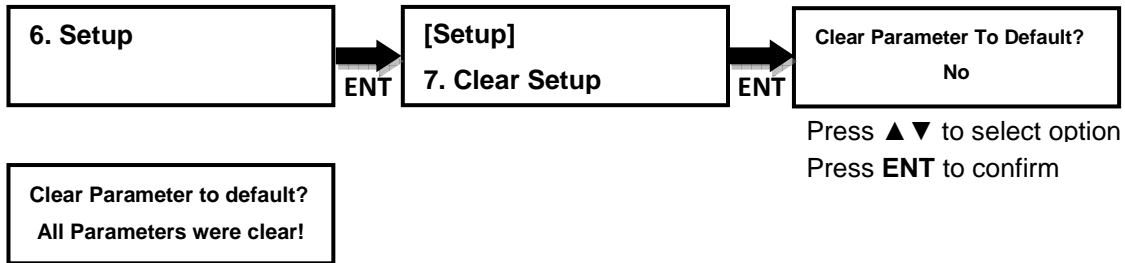

6.8 Advanced Setup

6.8.1 Power on Time

Allows user to set up power on time from “3” seconds to “120” seconds.

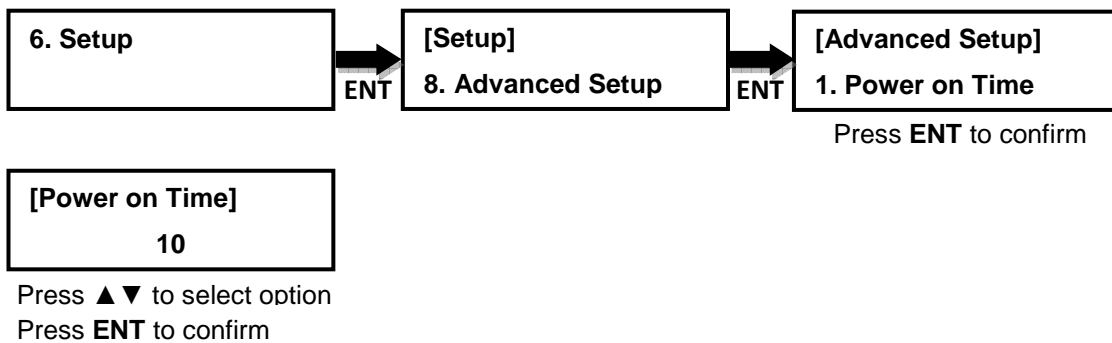

6.8.2 Boot Password

Allows user to set up password for the duplicator to prevent unauthorized use. Password can be up to 6 characters.

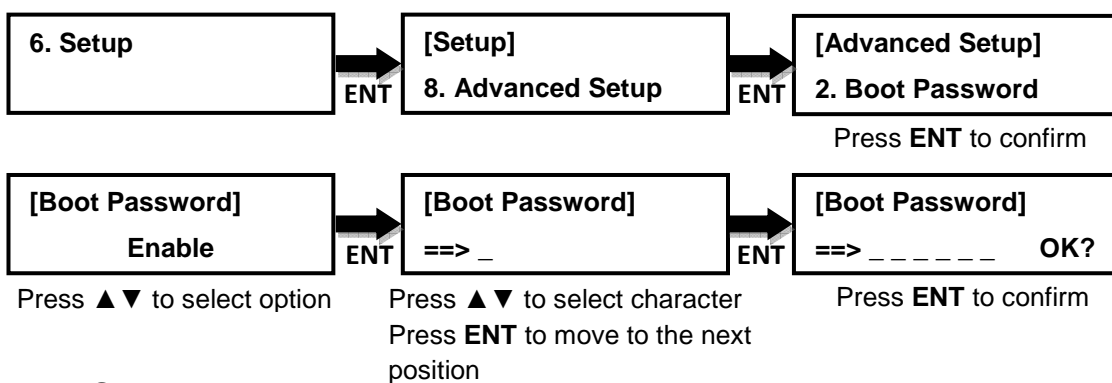

6.8.3 Set up Password

This allows user to set up a password to prevent any unauthorized changes to the system Setup.

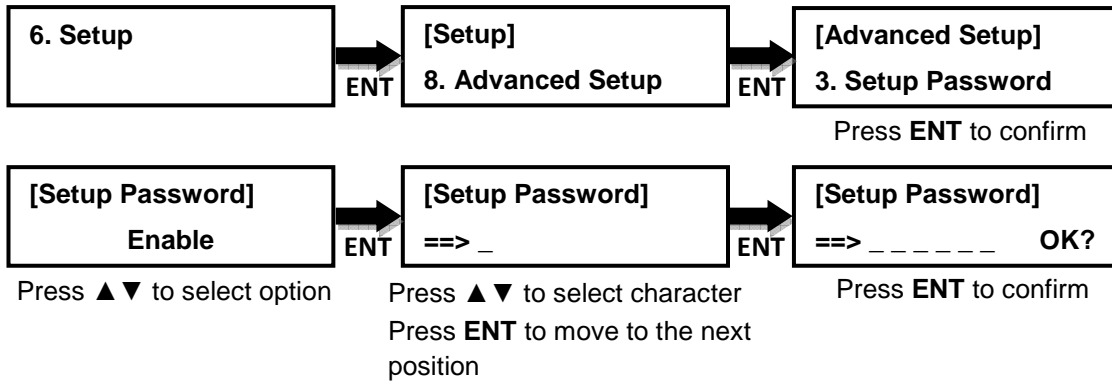

6.8.4 Performance

Allows user to choose the setting for best performance of duplication.

“**Speed**”: works at maximum data transfer rate.

“**Compatibility**”: provides maximum compatibility to the media but less data transfer rate.

“**Balance**”: maintains compatibility with media while keeps data transfer rate as possible.

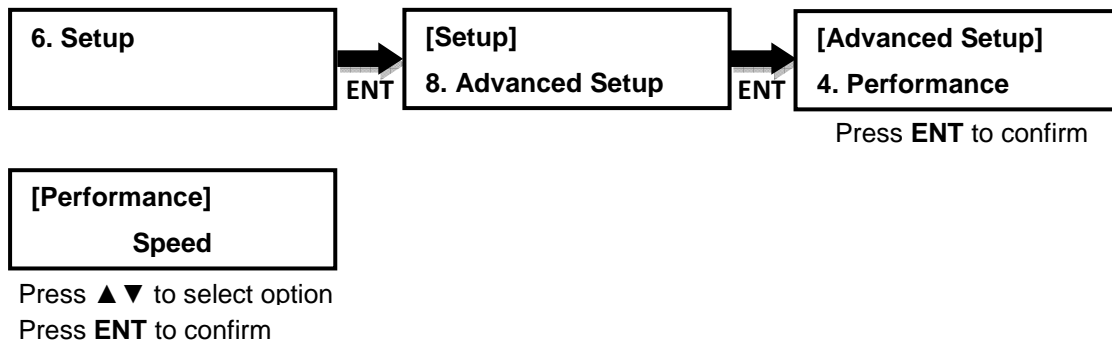

IV. Basic Troubleshooting

Follow these simple steps for quick and proper troubleshooting.

- 1:** Duplicator does not turn on or unit receives no power.
 - a.** Check power cord and power outlet to make sure power connections are secured.
 - b.** Check voltage switch on the back of the duplicator to make sure power supply is set to the correct outlet rating.
 - c.** Test with another power cord (same as a PC power cord) to eliminate cable failure.
- 2:** Master disc cannot be read
 - a.** Change the master disc. The master disc may be of poor quality or with error(s) that can make it difficult or impossible to duplicate.
 - b.** Remake the master disc on another disc. Master disc may be of poor quality or with error(s) that make duplication difficult or impossible.
 - c.** Change the source drive to one of the other drives to test.
 - d.** Make sure the master disc is finalized in standard ISO format.
- 3:** High failure rate
 - a.** Change the media type. Certain types of media may not be compatible with the optical drives. Poor-quality media can also cause high failure rate.
 - b.** Lower the burn speed and attempt another copy process. Lowering the speed increases the stability of the duplication process.
 - c.** Check for available firmware updates for the unit. A firmware update may resolve any unspecified issues.
- 4:** Machine locks up during the copy process
 - a.** Hold down the ESC button to abort the copy process. The copy process will cancel and menu goes back to the last function executed.
 - b.** If the cancel button does not work, power cycle the unit (power the unit off, leave off for five seconds and power the unit back on).
 - c.** Change the master disc. A master disc with error(s) or a poor quality master disc can cause duplication to lock up at particular points during the copy process.
- 5:** Button(s) do not function on the unit.
 - a.** The duplicator may be busy. Buttons pressed while the duplicator is under processing will not perform functions unless otherwise specified.
 - b.** Possible faulty button. Please contact our technical support department for further information.
- 6:** One of the drives does not open and/or LED does not light up
 - a.** Check USB switch and make sure the switch is in the OFF position before power is turned on if the duplicator comes with a USB port on the back.
 - b.** If a disc is stuck inside a drive, insert a paper clip or safety pin in the pinhole underneath the drive door and push gently. Make sure the power is OFF during this step. Then press the EJECT button of the drive a few times to test the disc tray.
- 7:** The blank CD/DVD/Blu-ray is not recognized in the writer drive(s)



- a.** Test the blank disc in another writer drive. A faulty writer drive will not recognize blank discs.
- b.** Change the blank disc to another disc. A defective blank disc will not be recognized by the writer drive.